

ECHO-MAGNETIC BUZZER

B67 SERIES



FEATURES:

- Ultra small size
- Low current consumption
- Extremely durable
- Long life
- Operating temperature -20°C --- $+70^{\circ}\text{C}$
- Storage temperature -30°C --- $+70^{\circ}\text{C}$

DIMENSIONS:

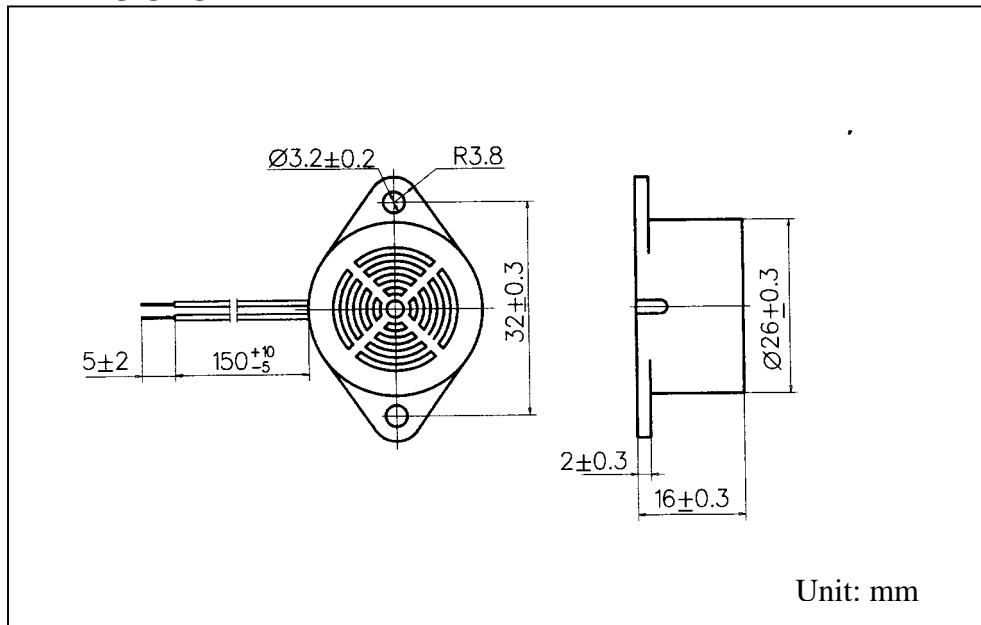

SPECIFICATIONS:

Model No.	Operating Voltage (VDC)	Rated Voltage (VDC)	Max. Current at Rated Voltage (mA)	Max. Response Time(ms)	Min. Sound Pressure at Rated Voltage (dBA/10cm)	Pulse Rate at Rated Voltage (Pulse/Sec)	Tone	Terminal
B67S3060L	4-8	6	33	150	95	NIL	SINGLE	LEAD
B67S3120L	7-16	12	23	150	95	NIL	SINGLE	LEAD
B67S3240L	20-28	24	21	150	95	NIL	SINGLE	LEAD