

ECHO-PIEZO BUZZER

B99 SERIES

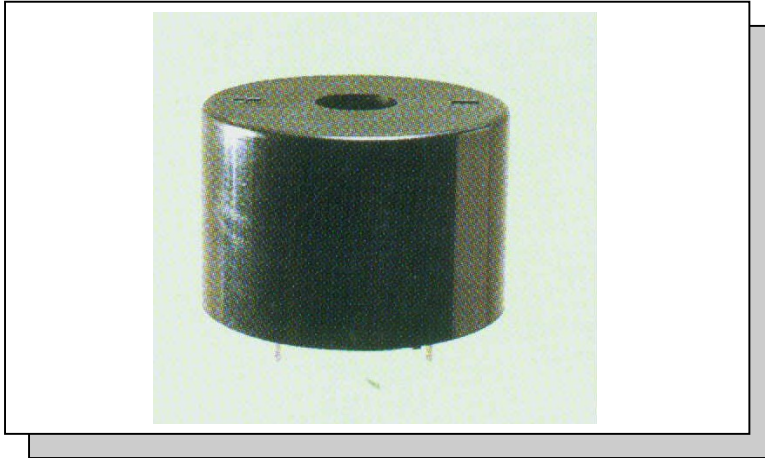

FEATURES:

- Loud sound output
- Ultra small size and lightweight
- Low current consumption
- Extremely durable & long life
- Operating temperature -20°C --- $+70^{\circ}\text{C}$
- Storage temperature -30°C --- $+70^{\circ}\text{C}$

DIMENSIONS: (unit: mm)

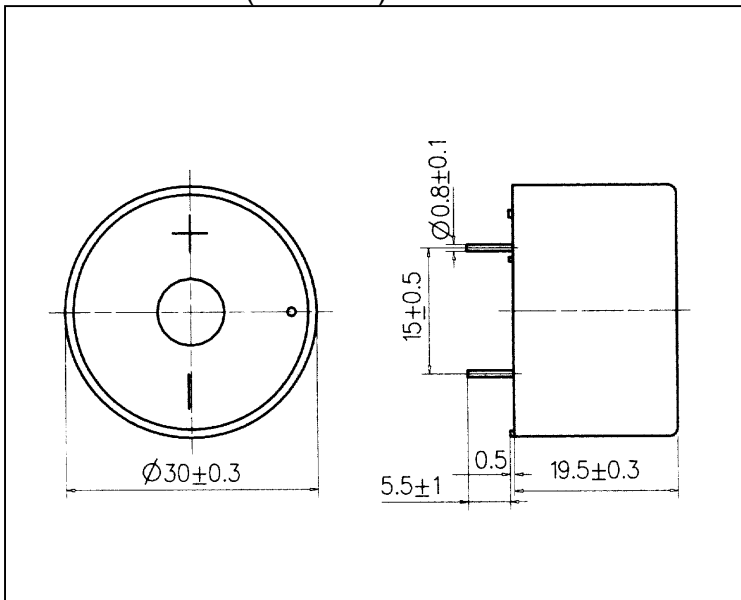

CHARACTERISTICS:

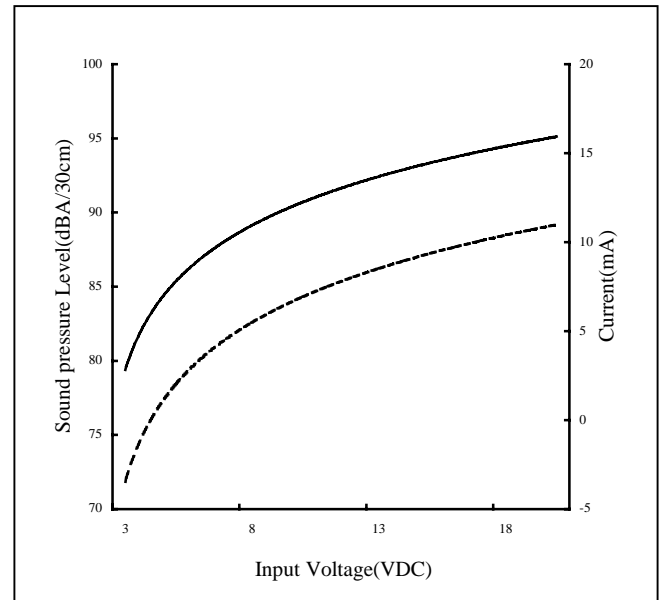

Remark: ——— Pressure level ----- Current

SPECIFICATIONS:

Model No.	Operating Voltage (VDC)	Rated Voltage (VDC)	Max.Current at Rated Voltage (mA)	Frequency (kHz)	Min. Sound Pressure at Rated Voltage (dBA/100cm)	Pulse Rate at Rated Voltage (Pulse/Sec)	Tone	Terminal
B99S3120P	3-20	12	10	3.6 ± 0.5	90	NIL	SINGLE	PIN

ECHO-PIEZO BUZZER

B99 SERIES

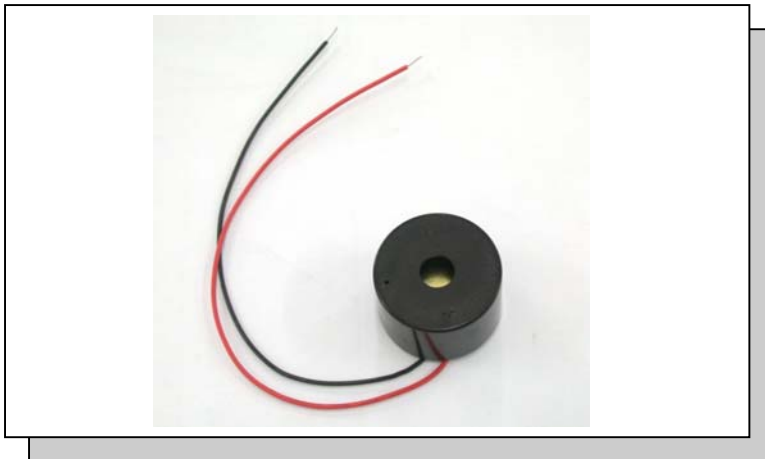

FEATURES:

- Loud sound output
- Ultra small size and lightweight
- Low current consumption
- Extremely durable & long life
- Operating temperature -20°C --- $+70^{\circ}\text{C}$
- Storage temperature -30°C --- $+70^{\circ}\text{C}$

DIMENSIONS: (unit: mm)

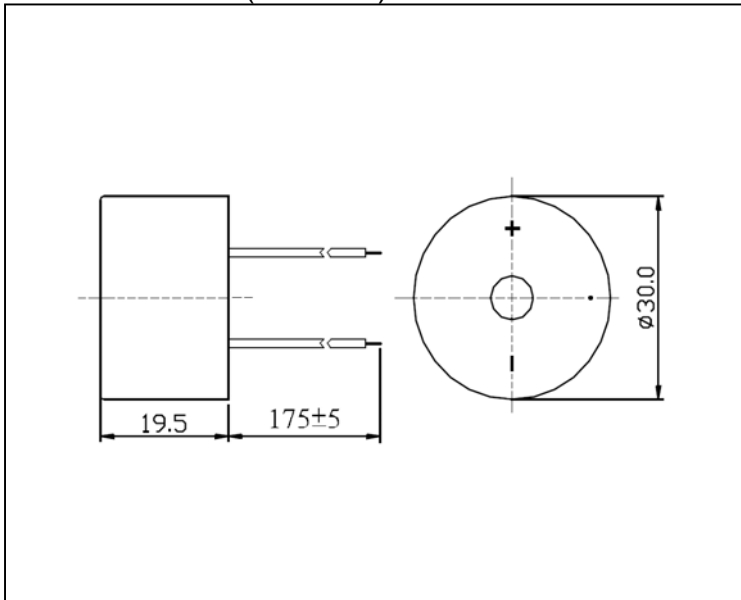

CHARACTERISTICS:

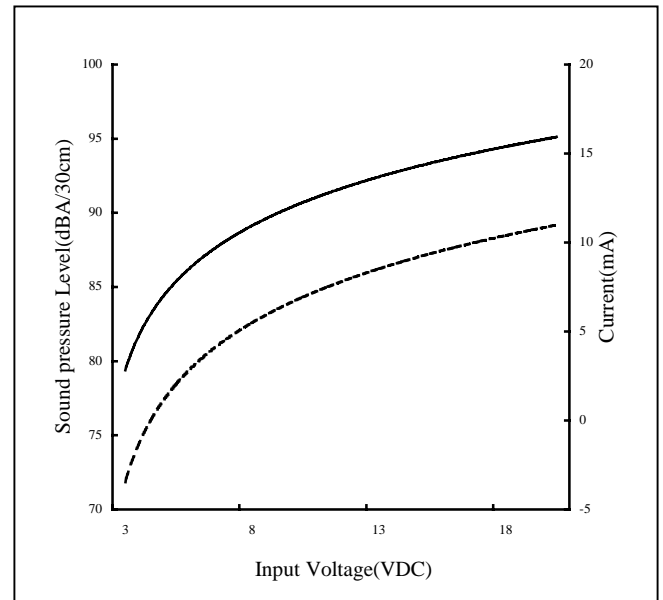

Remark: ——— Pressure level - - - - - Current

SPECIFICATIONS:

Model No.	Operating Voltage (VDC)	Rated Voltage (VDC)	Max.Current at Rated Voltage (mA)	Frequency (kHz)	Min. Sound Pressure at Rated Voltage (dBA/100cm)	Pulse Rate at Rated Voltage (Pulse/Sec)	Tone	Terminal
B99S3120L	3-20	12	10	3.6 ± 0.5	90	NIL	SINGLE	Wires